

PLACA DE CARACTERISTICAS
NAME PLATE

BARRENO PARA CONECTOR A TIERRA /
GROUND CONNECTOR

OREJAZ DE IZAJE Ø30
LIFTING HOLES

ROSCA PG-21/1" NPT
THREADED STUD PG-21/1" NPT

CAJA DE SALIDAS
SECUNDARIAS
(MAX. 20 SAL./M6)
SECONDARY TERMS.
(MAX. 20 TERM/M6)

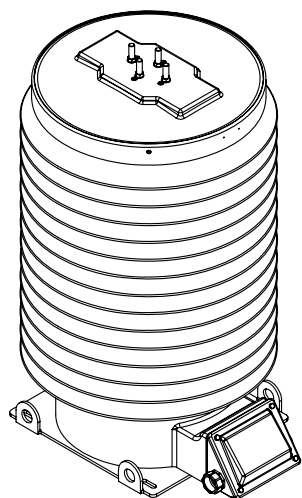
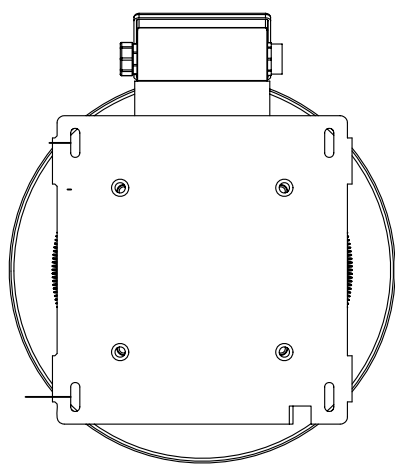

NEMA 2, HASTA/
UP TO 1200 AMPS

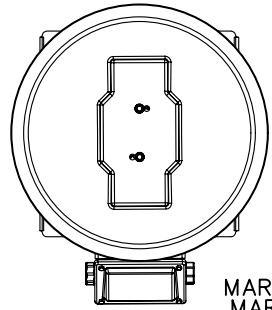

MARCA A
MARK A

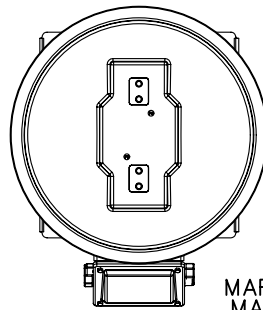

MARCA B
MARK B

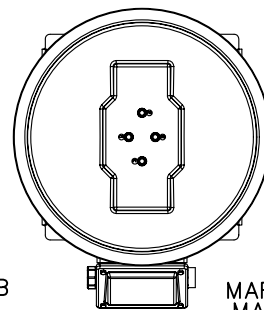

MARCA C
MARK C

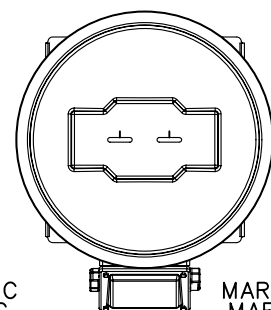

MARCA D
MARK D

Peso aprox./Approx.weight 235 Kg
Distancia de Fuga/Creepage dist. 2316 mm

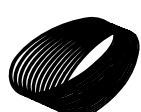

arteche

Dimensiones aproximadas en mm
Approximate dimensions in mm

TRANSFORMADOR DE CORRIENTE / CURRENT TRANSFORMER **CRK-72**

Fecha/Date 04/10/10 Comprobado/Checked R.E.S

N° Plano / Drawing N° 4285515A -1